

reacto PRO

FACILITÀ INSTALLAZIONE



INTERFACCIA UTENTE



ESPANDIBILITÀ



VERSATILITÀ



La potenza ad un altro livello? reacto PRO

L'avviamento ad impedenza contraddistingue **REACTO PRO**, il nuovo quadro di Elentek che unisce la completezza e la versatilità all'esigenza della pompa sommersa. Con la stessa interfaccia utente **semplice ed immediata**, che contraddistingue tutti i quadri Elentek, Reacto Pro ha 6 modalità preimpostate di utilizzo e ulteriori opzioni di connettività, controllo ed espandibilità.

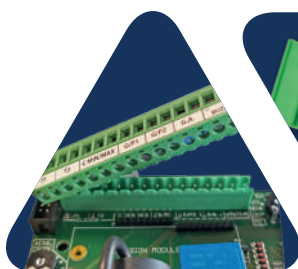

MORSETTIERA
ESTRAIBILE

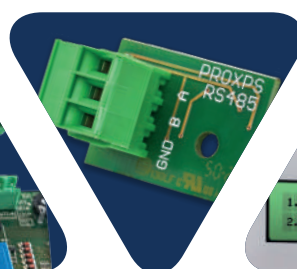

RS485
(Optional)



STORICO
ALLARMI



AFFIDABILE

Precisione nella lettura dell'assorbimento motore (anche in condizioni ambientali estreme)



SEMPRE PRESENTE

Grazie al display multilingua ogni operazione viene visualizzata



FLESSIBILE

Molteplicità di ingressi disponibili per svariate applicazioni



MASSIMO CONTROLLO

Integra le più complete protezioni del sistema

APPLICAZIONI

✓ PRESSURIZZAZIONE

✓ RIEMPIMENTO

✓ SVUOTAMENTO

✓ DRENAGGIO

CONNETTIVITÀ

MODULO PRESENZA ACQUA IN CAMERA OLIO

MODULO BATTERIA IN TAMPONE

MODULO BMS CONTATTI PULITI

MODULO BLUETOOTH PER APP

MODULO SONDE DI LIVELLO

MODULO RS485 MODBUS

CARATTERISTICHE PRINCIPALI

FUNZIONI

- Display LCD per visualizzazione e programmazione: tensione, corrente, cos-fi, ore di lavoro, n° avviamenti, stato motori, allarmi, segnale analogico e soglie
- Pulsanti funzionamento AUTOMATICO- 0 (standby) - MANUALE (fisso o a impulso)
- Impostazioni lingua (italiano, inglese, francese, spagnolo, tedesco)
- Autoprova antigrippaggio (programmabile)
- Protezione marcia a secco con: sonde di livello/ galleggianti/ pressostati e minima corrente
- Fino a 2 ingressi comando: galleggianti/ pressostati
- Ingresso per segnale analogico 4-20 mA o 0-10V
- Unità di misura segnale analogico cm - m - bar
- Ingressi start e stop di emergenza con modalità funzionamento segnale analogico (escludibile)
- Ingressi pastiglie termiche clicson con reset automatico (escludibile)
- Inversione ingressi (da normalmente aperti a normalmente chiusi)
- Ripristino automatico per allarme minima corrente con 4 tempi programmabili
- Ritardo attivazione da rientro rete (escludibile)
- Funzionamento pulsante manuale (fisso o momentaneo)
- Timer stella-triangolo regolabile

VERSIONI

- Versione trifase 310-450Vac 50/60Hz

CONTROLLI

- Controllo elettronico minima e massima tensione
- Controllo elettronico massima corrente motori
- Controllo elettronico minima corrente motori (marcia a secco)
- Controllo mancata o errata sequenza fasi in ingresso alimentazione (escludibile)

ALLARMI

- Allarmi segnalati: stato tensione, livelli, sovraccarico motore, minima corrente, clicson motore
- Storico allarmi
- Allarme troppi avviamenti/ora (impostabile)
- Contatti uscita allarme

PROTEZIONI

- Fusibili di protezioni ausiliari e motore
- Sezionatore generale blocco-porta (se previsto)
- Box metallico, IP55

reacto PRO 1

Codice	Modello	Tensione	Potenza massima cad.		Corrente cad.		Box		Peso	Prezzo
			Kw	Hp	Range	Max	Mod.	Materiale	Kg.	€
11073	REACTO PRO 1/11	3~400 V	11	15	16-25 A	25 A	M1	Metallico	32	1.273,00
11074	REACTO PRO 1/15	3~400 V	15	20	16-32 A	32 A	M2	Metallico	32	1.380,00
11075	REACTO PRO 1/18,5	3~400 V	18,5	25	30-38A	38 A	M3	Metallico	32	1.704,00
11076	REACTO PRO 1/22	3~400 V	22	30	30-50A	50 A	M3	Metallico	32	1.872,00
11077	REACTO PRO 1/30	3~400 V	30	40	30-60A	60 A	M4	Metallico	40	2.172,00
11078	REACTO PRO 1/37	3~400 V	37	50	45-75A	75 A	M4	Metallico	40	2.369,00
11079	REACTO PRO 1/45	3~400 V	45	60	45-100A	100 A	M4	Metallico	40	2.882,00

Tipologia di collegamento 1

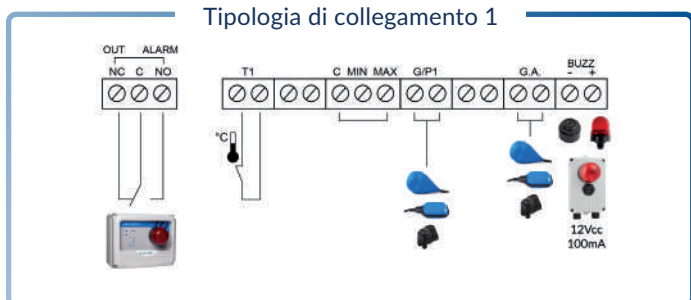

Tipologia di collegamento 2

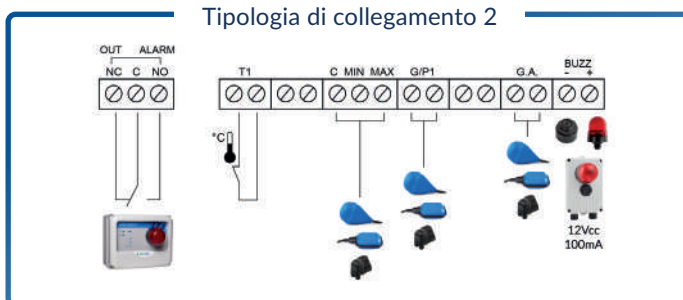

Tipologia di collegamento 3

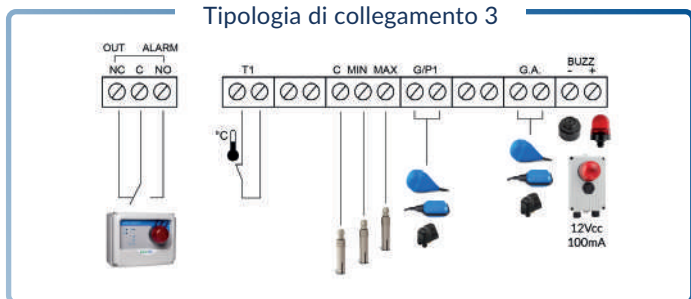

Tipologia di collegamento 4

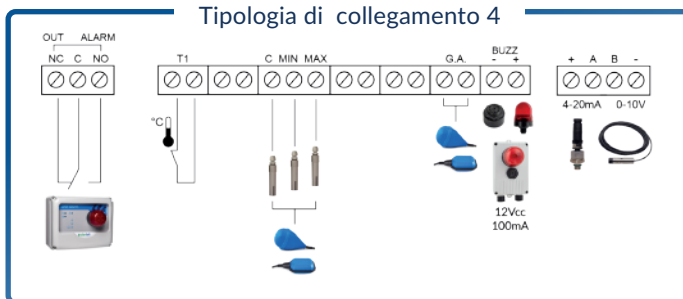

ACCESSORI

Codice	Modello	Descrizione	€
98007	K3SL	Kit 3 sonde (elettrodi) di livello	34,00
99050	PM/5	Pressostato 1-5 bar	18,00
99051	PM/12	Pressostato 3-12 bar	22,00
98003.012	AA-12Vdc	Allarme acustico 90 dB 12Vdc	57,00
98004.012	LL-12Vac/dc	Lampada lampeggiante di allarme 12V AC/DC	97,00
98022	FE	Fungo d'emergenza	37,00
98029	DT	Orologio giornaliero a cavalieri	110,00
98030	WT	Orologio settimanale digitale	159,00
98032	TPL	Timer pausa/lavoro	106,00
98033	CI24Vac	Comando esterno in 24Vac per attivazione/spegnimento utenza	34,00
98033A	CI230Vac	Comando esterno in 230Vac per attivazione/spegnimento utenza	34,00



ESPANSIONI

Codice	Modello	Descrizione	€
98102	PRO-XPS	Modulo PROXPS RS485 Modbus	66,00
98103*	PRO-SL	Modulo sonde di livello PRO-SL	155,00
98104*	PRO-H2O	Modulo presenza acqua in camera olio PRO-SL H2O	109,00
98105*	PRO-6DO	Modulo BMS contatti puliti	88,00
98106	PRO-DBT	Modulo batteria in tampone PRODBT	133,00
98107	PRO-BT	Modulo bluetooth per App PROXPS-BT	76,00

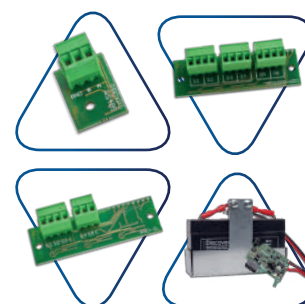

*È possibile scegliere solo 1 tra le espansioni: 98103 / 98104 / 98105

PRODOTTI CORRELATI

Codice	Modello	Descrizione	€
99034	FLO 10	Galleggiante con cavo in neoprene lunghezza 10 m	41,00
99036	DROP 10	Galleggiante ad assetto variabile con cavo in neoprene lunghezza 10 m	73,00
99039	SHELL	Contrappeso in polipropilene per galleggianti	5,00
01503	FLASH 12	Quadro di allarme acustico/visivo	125,00
01500	UNIT ALARM 1	Quadro di allarme acustico con batteria in tampone	160,00
01501	UNIT ALARM 2	Quadro di allarme acustico/visivo con batteria in tampone	250,00
01502	UNIT ALARM GSM	Quadro di allarme acustico/visivo con batteria in tampone e kit GSM	707,00
98044	TP010B	Trasduttore di pressione 0-10Bar 4-20mA	129,00
98045	TP016B	Trasduttore di pressione 0-16Bar 4-20mA	129,00
97007	E-KIOSK	Colonnina portaquadro in polietilene	494,00
pag. 72	MANIFOLD	Collettori in acciaio inox	pag. 72
99009	BASE FULL	Base per gruppi di pressione a 2 pompe orizzontali e verticali	164,00



MODELLI

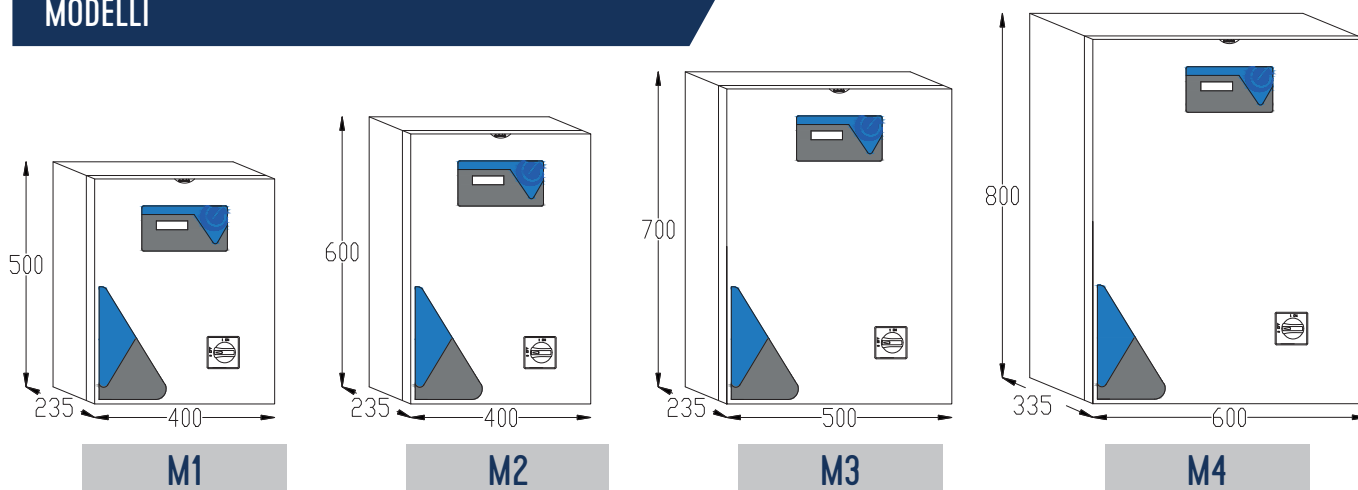

reacto PRO

EASE OF INSTALLATION



USER INTERFACE



SCALABILITY



VERSATILITÀ



Power to the next level? reacto PRO

The impedance start distinguishes **REACTO PRO**, the new panel from Elentek that combines completeness and versatility with the needs of submersible pumps.

With the same **simple and intuitive user interface** that characterizes all Elentek panels, Reacto Pro has **6 preset usage modes** and additional options for connectivity, control, and expandability.

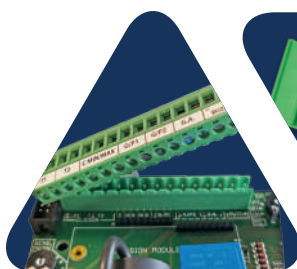

REMOVABLE
TERMINAL BLOCK

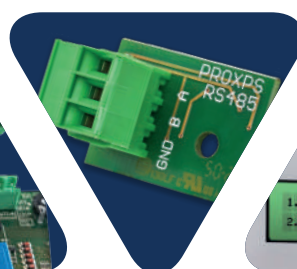

RS485
(Optional)



ALARM
HISTORY



RELIABLE

Precision in reading motor power consumption (even in extreme environmental conditions)



ALWAYS PRESENT

Thanks to the multilingual display, every operation is displayed



FLEXIBLE

A variety of available inputs for various applications



MAXIMUM CONTROL

Integrates the most comprehensive system protections

APPLICATIONS

✓ PRESSURIZATION

✓ FILLING

✓ EMPTYING

✓ DRAINAGE

CONNECTIVITY

WATER PRESENCE MODULE IN OIL CHAMBER

BMS MODULE WITH CLEAN CONTACTS

BLUETOOTH MODULE FOR APP

BACKUP BATTERY MODULE

RS485 MODBUS MODULE

LEVEL SENSOR MODULE

MAIN FEATURES

FUNCTIONS

- LCD display for viewing and programming: voltage, current, cos-fi, operating hours, number of starts, motor status, alarms, analog signal, and thresholds
- Operation buttons: AUTOMATIC - 0 (standby) - MANUAL (fixed or momentary)
- Language settings (Italian, English, French, Spanish, German)
- Anti-seize self-test (programmable)
- Dry run protection with: level probes/float switches/pressure switches and minimum current
- Up to 2 command inputs: float switches/pressure switches
- Input for analog signal 4-20 mA or 0-10V
- Units of measurement for analog signal: cm – m – bar
- Emergency start and stop inputs with analog signal operation mode (can be excluded)
- Thermal overload contacts with automatic reset (can be excluded)
- Input reversal (from normally open to normally closed)
- Automatic reset for minimum current alarm with 4 programmable delays
- Network return activation delay (can be excluded)
- Manual button operation (fixed or momentary)
- Adjustable star-delta timer

VERSIONS

- Three-phase version 310-450Vac 50/60Hz

CONTROLS

- Electronic minimum and maximum voltage control
- Electronic maximum motor current control
- Electronic minimum motor current control (dry run)
- Control of missing or incorrect phase sequence in power supply input (can be excluded)

ALARMS

- Alarms reported: voltage status, levels, motor overload, minimum current, motor thermal overload
- Alarm history
- Too many starts/hour alarm (settable)
- Alarm output contacts

PROTECTIONS

- Auxiliary and motor protection fuses
- Main disconnect switch with door lock (if provided)
- Metal enclosure, IP55

reacto PRO 1

Code	Model	Voltage	Maximum power		Current		Box		W	Price
			Kw	Hp	Range	Max	Mod.	Material	Kg.	€
11073	REACTO PRO 1/11	3~400 V	11	15	16-25 A	25 A	M1	Metallic	32	1.273,00
11074	REACTO PRO 1/15	3~400 V	15	20	16-32 A	32 A	M2	Metallic	32	1.380,00
11075	REACTO PRO 1/18,5	3~400 V	18,5	25	30-38A	38 A	M3	Metallic	32	1.704,00
11076	REACTO PRO 1/22	3~400 V	22	30	30-50A	50 A	M3	Metallic	32	1.872,00
11077	REACTO PRO 1/30	3~400 V	30	40	30-60A	60 A	M4	Metallic	40	2.172,00
11078	REACTO PRO 1/37	3~400 V	37	50	45-75A	75 A	M4	Metallic	40	2.369,00
11079	REACTO PRO 1/45	3~400 V	45	60	45-100A	100 A	M4	Metallic	40	2.882,00

Type of connection 1

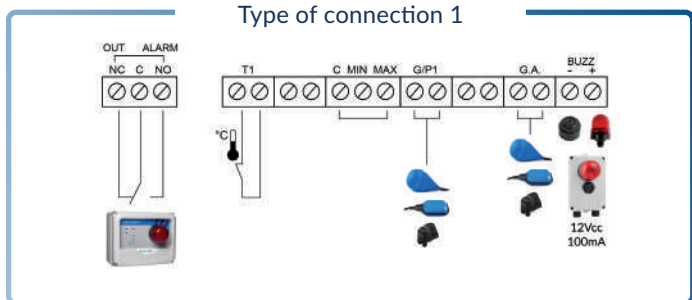

Type of connection 2

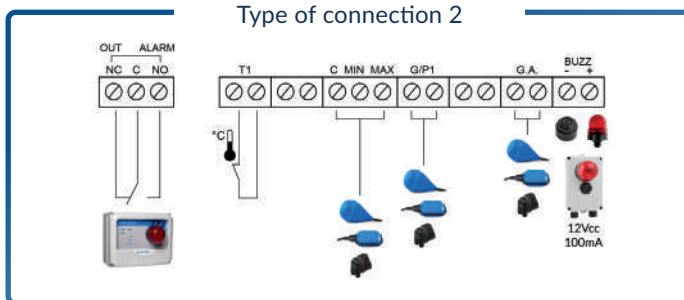

Type of connection 3

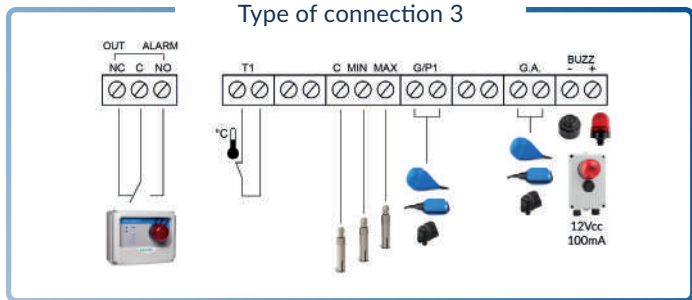

Type of connection 4

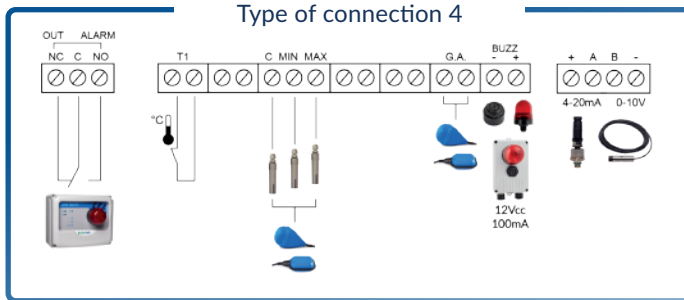

ACCESSORIES

Code	Model	Description	€
98007	K3SL	Kit of 3 level probes (electrodes)	34,00
99050	PM/5	Pressure switch 1-5 bar	18,00
99051	PM/12	Pressure switch 3-12 bar	22,00
98003.012	AA-12Vdc	90 dB 12Vdc acoustic alarm	57,00
98004.012	LL-12Vac/dc	12V AC/DC flashing alarm lamp	97,00
98022	FE	Emergency stop button	37,00
98029	DT	Daily mechanical timer	110,00
98030	WT	Digital weekly timer	159,00
98032	TPL	Pause/work timer	106,00
98033	CI24Vac	External 24Vac command for activation/turn off of load	34,00
98033A	CI230Vac	External 230Vac command for activation/turn off of load	34,00



EXPANSIONS

Code	Model	Description	€
98102	PRO-XPS	PROXPS RS485 Modbus module	66,00
98103*	PRO-SL	PRO-SL level sensor module	155,00
98104*	PRO-H2O	PRO-SL H2O water presence module in oil chamber	109,00
98105*	PRO-6DO	BMS module with clean contacts	88,00
98106	PRO-DBT	PRODBT backup battery module	133,00
98107	PRO-BT	Bluetooth module for App PROXPS-BT	76,00

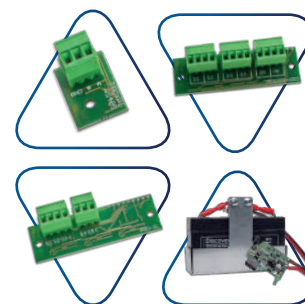

*It is possible to choose only one between the expansions: 98103 / 98104 / 98105

RELATED PRODUCTS

Code	Model	Description	€
99034	FLO 10	Neoprene cable float, 10 m length	41,00
99036	DROP 10	Variable tilt float with neoprene cable, 10 m length	73,00
99039	SHELL	Polypropylene counterweight for floats	5,00
01503	FLASH 12	Acoustic/visual alarm panel	125,00
01500	UNIT ALARM 1	Acoustic alarm panel with backup battery	160,00
01501	UNIT ALARM 2	Acoustic/visual alarm panel with backup battery	250,00
01502	UNIT ALARM GSM	Acoustic/visual alarm panel with backup battery and GSM kit	707,00
98044	TP010B	Pressure transducer 0-10Bar 4-20mA	129,00
98045	TP016B	Pressure transducer 0-16Bar 4-20mA	129,00
97007	E-KIOSK	Polyethylene panel stand	494,00
pag. 72	MANIFOLD	Stainless steel collectors	pag. 72
99009	BASE FULL	Base for pressure groups with 2 horizontal and vertical pumps	164,00



DIMENSIONS

