

stardelta PRO

FACILITÀ INSTALLAZIONE



INTERFACCIA UTENTE



ESPANDIBILITÀ



VERSATILITÀ



Potenza e controllo? stardelta PRO

L'avviamento stella-triangolo contraddistingue **STARDELTA PRO**, il nuovo quadro di Elentek che aggiunge, alla completezza, versatilità e praticità, la riduzione delle correnti di spunto e delle sollecitazioni meccaniche.

Con la stessa interfaccia utente semplice ed immediata, che contraddistingue tutta la gamma Elentek, Stardelta Pro ha **6 modalità preimpostate** di utilizzo, ulteriori opzioni di connettività, controllo ed espandibilità.

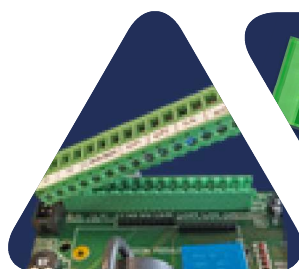

MORSETTIERA
ESTRAIBILE

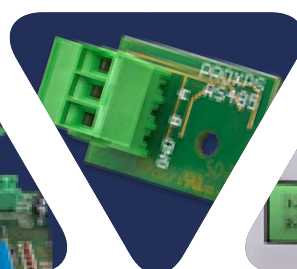

RS485
(Optional)



STORICO
ALLARMI



AFFIDABILE IN QUALSIASI CONDIZIONE

Il quadro con molteplici applicazioni economicamente competitivo

SEMPRE PRESENTE

Grazie al display multilingua ogni operazione viene visualizzata

FLESSIBILITÀ

Molteplicità di ingressi disponibili per svariate applicazioni

MASSIMO CONTROLLO

Integra le più complete protezioni del sistema

APPLICAZIONI

✓ PRESSURIZZAZIONE

✓ RIEMPIMENTO

✓ SVUOTAMENTO

✓ DRENAGGIO

CONNETTIVITÀ

MODULO PRESENZA ACQUA IN CAMERA OLIO

MODULO WI-FI BLUETOOTH PER APP

MODULO BATTERIA IN TAMPONE

MODULO BMS CONTATTI PULITI

MODULO SONDE DI LIVELLO

MODULO RS485 MODBUS

CARATTERISTICHE PRINCIPALI

FUNZIONI

- Display LCD per visualizzazione e programmazione: tensione, corrente, cos-fi, ore di lavoro, n° avviamenti, stato motori, allarmi, segnale analogico e soglie
- Pulsanti funzionamento AUTOMATICO- 0 (standby) – MANUALE (fisso o a impulso)
- Impostazioni lingua (italiano, inglese, francese, spagnolo, tedesco)
- Autoprova antigrippaggio (programmabile)
- Protezione marcia a secco con: sonde di livello/ galleggianti/ pressostati e minima corrente
- Fino a 2 ingressi comando: galleggianti/ pressostati
- Ingresso per segnale analogico 4-20 mA o 0-10V
- Unità di misura segnale analogico cm – m – bar
- Ingressi start e stop di emergenza con modalità funzionamento segnale analogico (escludibile)
- Ingressi pastiglie termiche clicson con reset automatico (escludibile)
- Inversione ingressi (da normalmente aperti a normalmente chiusi)
- Ripristino automatico per allarme minima corrente con 4 tempi programmabili
- Ritardo attivazione da rientro rete (escludibile)
- Funzionamento pulsante manuale (fisso o momentaneo)
- Timer stella-triangolo regolabile

VERSIONI

- Versione trifase 310-450Vac 50/60Hz

CONTROLLI

- Controllo elettronico minima e massima tensione
- Controllo elettronico massima corrente motori
- Controllo elettronico minima corrente motori (marcia a secco)
- Controllo mancata o errata sequenza fasi in ingresso alimentazione (escludibile)

ALLARMI

- Allarmi segnalati: stato tensione, livelli, sovraccarico motore, minima corrente, clicson motore
- Storico allarmi
- Allarme troppi avviamenti/ora (impostabile)
- Contatti uscita allarme

PROTEZIONI

- Fusibili di protezioni ausiliari e motore
- Sezionatore generale blocco-porta (se previsto)
- Box metallico, IP55

ACCESSORI

Codice	Modello	Descrizione
98007	K3SL	Kit 3 sonde (elettrodi) di livello
99050	PM/5	Pressostato 1-5 bar
99051	PM/12	Pressostato 3-12 bar
98003.012	AA-12Vdc	Allarme acustico 90 dB 12Vdc
98004.012	LL-12Vac/dc	Lampada lampeggiante di allarme 12V AC/DC
98022	FE	Fungo d'emergenza
98029	DT	Orologio giornaliero a cavalieri
98030	WT	Orologio settimanale digitale
98032	TPL	Timer pausa/lavoro
98033	CI24Vac	Comando esterno in 24Vac per attivazione/spegnimento utenza
98033A	CI230Vac	Comando esterno in 230Vac per attivazione/spegnimento utenza



ESPANSIONI

Codice	Modello	Descrizione
98102	PRO-XPS	Modulo PROXPS RS485 Modbus
98103	PRO-SL	Modulo sonde di livello PRO-SL
98104	PRO-H2O	Modulo presenza acqua in camera olio PRO-SL H2O
98105	PRO-6DO	Modulo BMS contatti puliti
98106	PRO-DBT	Modulo batteria in tampone PRODBT
98107	PRO-WiFi	Modulo wi-fi bluetooth per App PROXPS-WiFi/BT

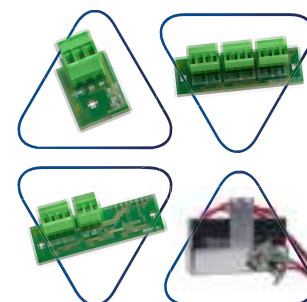

PRODOTTI CORRELATI

Codice	Modello	Descrizione
99034	FLO 10	Galleggiante con cavo in neoprene lunghezza 10 m
99036	DROP 10	Galleggiante ad assetto variabile con cavo in neoprene lunghezza 10 m
99039	SHELL	Contrappeso in polipropene per galleggianti
01503	FLASH 12	Quadro di allarme acustico/visivo
01500	UNIT ALARM 1	Quadro di allarme acustico con batteria in tampone
01501	UNIT ALARM 2	Quadro di allarme acustico/visivo con batteria in tampone
01502	UNIT ALARM GSM	Quadro di allarme acustico/visivo con batteria in tampone e kit GSM
98044	TP010B	Trasduttore di pressione 0-10Bar 4-20mA
98045	TP016B	Trasduttore di pressione 0-16Bar 4-20mA
pag. 54	MANIFOLD	Collettori in acciaio inox
97007	E-KIOSK	Colonnina portaquadro in polietilene
99009	BASE FULL	Base per gruppi di pressione a 2 pompe orizzontali e verticali

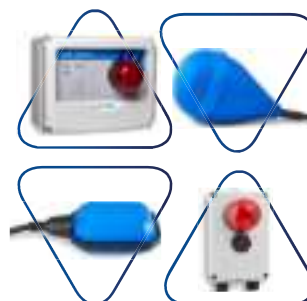

MODELLI

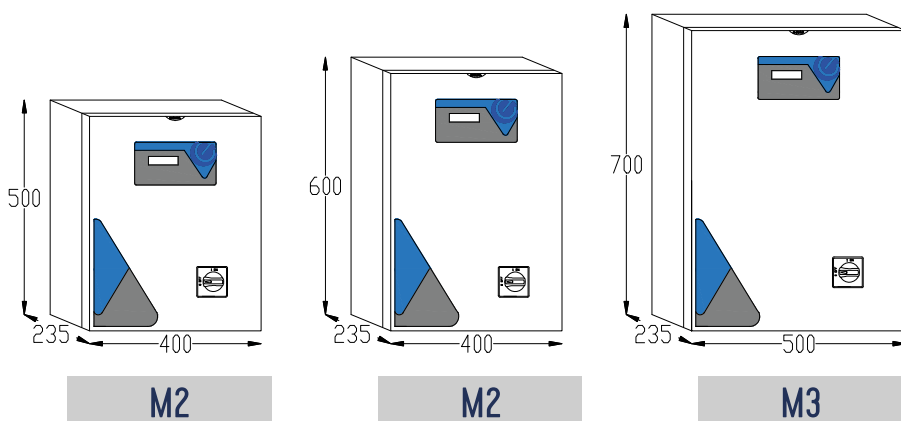

stardelta PRO

EASY INSTALLATION



USER INTERFACE



EXPANDABILITY



VERSATILITY



Power and control? stardelta PRO

Star-delta start is the main feature distinguishing **STARDELTA PRO**, Elentek new control panel adding the reduction of start currents and mechanical stress to completeness, versatility and handiness.

With the same simple and immediate user interface distinguishing the entire Elentek range, Stardelta Pro has **6 preset operating modes**, additional connectivity options, control and expandability.

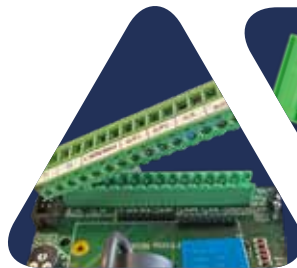

TERMINAL BLOCK
REMOVABLE

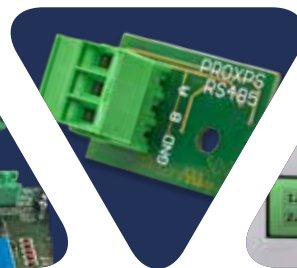

RS485
(Optional)



HISTORICAL
ALARMS



MAXIMUM CONTROL

Integrate the most complete system protections

FLEXIBILITY

Multiple inputs available for several applications

ALWAYS PRESENT

Every operation is shown on the multilingual display

RELIABLE IN ANY CONDITION

Accurate motor current reading (even in extreme ambient conditions)

APPLICATIONS

✓ PRESSURISATION

✓ FILLING

✓ EMPTYING

✓ DRAINAGE

CONNECTIVITY

BMS FREE VOLTAGE CONTACTS MODULE

BLUETOOTH WI-FI MODULE FOR APP

WATER IN OIL CHAMBER MODULE

BUFFER BATTERY MODULE

RS485 MODBUS MODULE

LEVEL PROBES MODULE

TECHNICAL FEATURES

FUNCTIONS

- LCD display for displaying and programming: voltage, current, cos-φ, hours of operation, number of starts, motor status, alarms, analogue signal and thresholds
- Selector AUTOMATIC - 0 (standby) - MANUAL operation
- Language settings (Italian, English, French, Spanish, German)
- Anti-seize autotest (programmable)
- Dry running protection with: level probes/ floats/ pressure switches and minimum current
- Up to 2 control inputs: float/pressure switches
- Input for 4-20 mA or 0-10V analogue signal
- Unit of measurement analogue signal cm - m - bar
- Emergency start and stop inputs with analogue signal operation mode (can be disabled)
- Clicson thermal pad inputs with automatic reset (can be disabled)
- Inversion of inputs (from normally open to normally closed)
- Automatic reset due to minimum current alarm with 4 programmable times
- Activation delay from mains return (can be disabled)
- Manual button operation (fixed or pulse)
- Settable star-delta timer

VERSIONS

- Power supply 3phase 310-450Vac 50/60Hz

CONTROLS

- Electronic minimum and maximum voltage control
- Electronic control of maximum motor current
- Minimum motor current control
- Failure or incorrect phase sequence control on power supply input (can be disabled)

ALARMS

- Alarms reported: voltage status, levels, motor overload, minimum current, motor clicson
- Alarm history
- Starts / hour alarm (settable)
- Alarm output contacts

PROTECTIONS

- Auxiliary and motor protection fuses
- Isolator (except for NB code)
- Metallic box, IP55

stardelta PRO 1

Code	Model	Voltage	Max power		Current		Box		Weight
			Kw	Hp	Range	Max	Mod.	Material	Kg.
11054	STARDELTA PRO 1/11	3~400 V	11	15	16-25 A	25 A	M1	Metallic	16
11055	STARDELTA PRO 1/15	3~400 V	15	20	16-32 A	32 A	M1	Metallic	16
11056	STARDELTA PRO 1/18,5	3~400 V	18,5	25	30-38A	38 A	M2	Metallic	16
11057	STARDELTA PRO 1/22	3~400 V	22	30	30-50A	50 A	M2	Metallic	16
11058	STARDELTA PRO 1/30	3~400 V	30	40	30-60A	60 A	M2	Metallic	20
11059	STARDELTA PRO 1/37	3~400 V	37	50	45-75A	75 A	M3	Metallic	30
11060	STARDELTA PRO 1/45	3~400 V	45	60	45-100A	100 A	M3	Metallic	30

Connection type 1

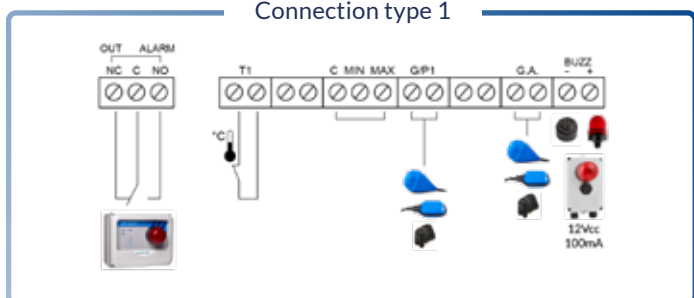

Connection type 2

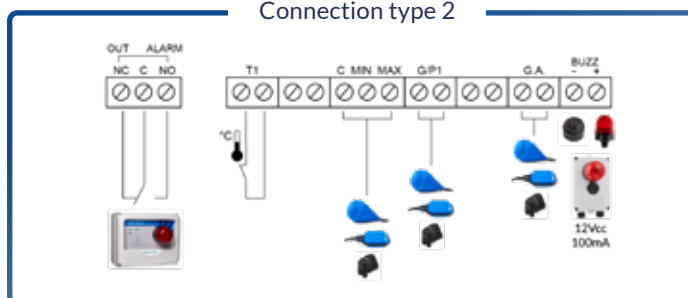

Connection type 3

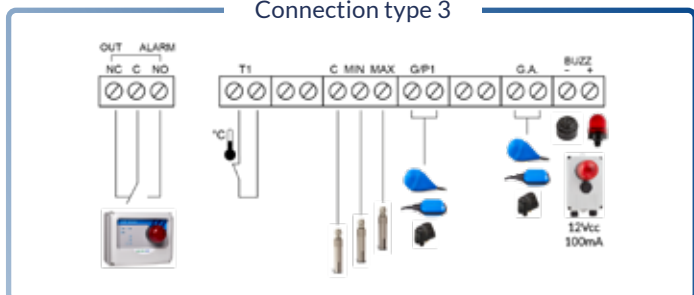

Connection type 4

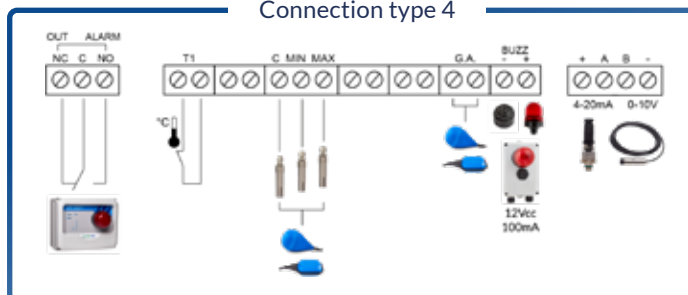

ACCESSORIES

Code	Model	Description
98007	K3SL	Kit of 3 level probes (electrodes)
99050	PM/5	Pressure switch 1-5 bar
99051	PM/12	Pressure switch 3-12 bar
98003.012	AA-12Vdc	Acoustic alarm 90 dB 12Vdc
98004.012	LL-12Vac/dc	Flashing alarm 12V AC/DC
98022	FE	Emergency pushbutton
98029	DT	Daily timer with switch-riders
98030	WT	Weekly digital timer
98032	TPL	Pause/work timer
98033	CI24Vac	External 24Vac input for activation/deactivation of the motor
98033A	CI230Vac	External 230Vac input for activation/deactivation of the motor



EXPANSIONS

Code	Model	Description
98102	PRO-XPS	PROXPS RS485 Modbus module
98103*	PRO-SL	PRO-SL level probe module
98104*	PRO-H2O	PRO-SL H2O Oil Chamber Water Presence Module
98105*	PRO-6DO	BMS dry contacts module
98106	PRO-DBT	PRODBT buffer battery module
98107	PRO-WiFi	Bluetooth wi-fi module for App PROXPS-WiFi / BT

*Only 1 of the expansions can be chosen: 98103 / 98104 / 98105

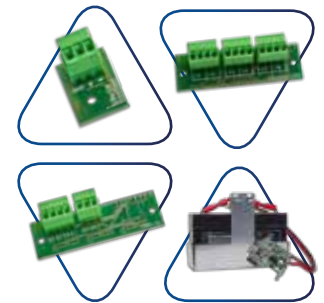

RELATED PRODUCTS

Code	Model	Description
99034	FLO 10	Float switch with neoprene cable length 10 m
99036	DROP 10	Variable float switch with neoprene cable length 10 m
99039	SHELL	Counterweight
01503	FLASH 12	Acoustic/visual alarm panel
01500	UNIT ALARM 1	Acoustic alarm panel with buffer battery
01501	UNIT ALARM 2	Acoustic/visual alarm panel with buffer battery
01502	UNIT ALARM GSM	Acoustic/visual alarm panel with buffer battery and GSM kit
98044	TP010B	Pressure transducer 0-10Bar 4-20mA
98045	TP016B	Pressure transducer 0-16Bar 4-20mA
pag. 54	MANIFOLD	Stainless steel manifolds
97007	E-KIOSK	Polyethylene panel column
99009	BASE FULL	Base for horizontal and vertical 2-pump booster kits



MODELS

